

# High Speed Steel Burrs

Burrs are priced per 6 pack of one size

3/32" Shaft - Requires Dremel 481 Collet

\$69.50 Size 010  
\$69.50 Size 015  
\$69.50 Size 020

\$69.50 Size 025  
\$69.50 Size 030  
\$109.50 Size 040  
\$109.50 Size 050

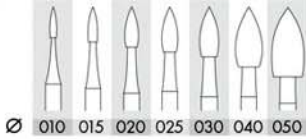
Series G Flame

\$49.50 Sizes 006 - 023  
\$69.50 Sizes 025 - 037  
\$109.00 Sizes 040 - 050

Series Z Bud

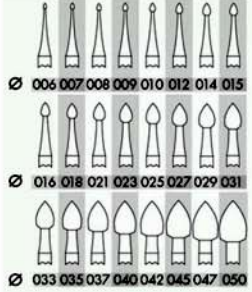
\$19.50 Sizes 005 - 023  
\$39.50 Sizes 024 - 029

Series 23 Round

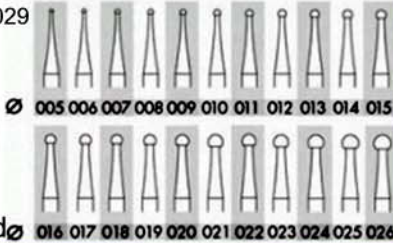
\$21.50 Sizes 007 - 023  
\$39.50 Sizes 025 - 027

Series 34 Cylinder

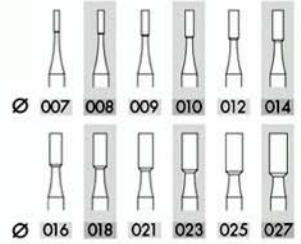
\$19.50 Sizes 007 - 023  
\$39.50 Sizes 025 - 029

Series 24 Inverted Cone

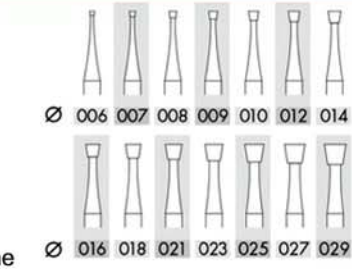
\$21.50 Sizes 007 - 023  
\$39.50 Sizes 025 - 027

Series 26 Cylinder

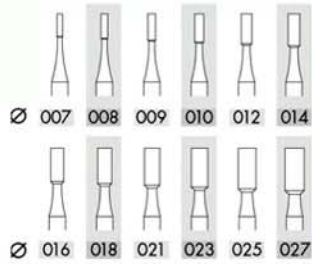
\$21.50 Sizes 007 - 021  
\$39.50 Sizes 023 - 025



Series 38 Cone

\$21.50 Sizes 007 - 023  
\$39.50 Sizes 025 - 027

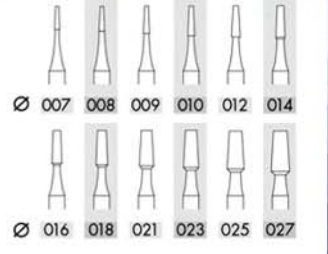
Series 31 Cone

Each pack of 6 contains all the same size burrs.

A pack of 31/012 contains 6x 31 series cone burrs size 12 NO MIXED PACKS AVAILABLE

005 = 0.5mm	014 = 1.4mm	023 = 2.3mm	032 = 3.2mm	041 = 4.1mm
006 = 0.6mm	015 = 1.5mm	024 = 2.4mm	033 = 3.3mm	042 = 4.2mm
007 = 0.7mm	016 = 1.6mm	025 = 2.5mm	034 = 3.4mm	044 = 4.4mm
008 = 0.8mm	017 = 1.7mm	026 = 2.6mm	035 = 3.5mm	045 = 4.5mm
009 = 0.9mm	018 = 1.8mm	027 = 2.7mm	036 = 3.6mm	046 = 4.6mm
010 = 1.0mm	019 = 1.9mm	028 = 2.8mm	037 = 3.7mm	047 = 4.7mm
011 = 1.1mm	020 = 2.0mm	029 = 2.9mm	038 = 3.8mm	048 = 4.8mm
012 = 1.2mm	021 = 2.1mm	030 = 3.0mm	039 = 3.9mm	049 = 4.9mm
013 = 1.3mm	022 = 2.2mm	031 = 3.1mm	040 = 4.0mm	050 = 5.0mm

# Treated Steel Burrs

Burrs are priced each

## 51 Series : 1/8" Shaft - requires Dremel 480 Collet

1/4" Diameter Head 1 3/4" overall length Double Cut 1/8th Shank Heat treated Steel

\$34.90



CODE	DIA	LENGTH	SHANK	SHAPE
SA-51	1/4	1/2	1/8	CYLINDER
SB-51	1/4	3/16	1/8	CYLINDER
SC-51	1/4	1/2	1/8	CYLINDER RAD END
SD-51	1/4	7/32	1/8	BALL END
SE-51	1/4	3/8	1/8	OVAL
SF-51	1/4	1/2	1/8	ROUND TREE
SG-51	1/4	1/2	1/8	POINTED TREE
SM-51	1/4	1/2	1/8	22 DEGREE CONE
SN-51	1/4	1/4	1/8	INVERTED CONE

## Large Standard Burrs

Aluminium Cutting Burrs Single Cut choice of 6mm or 1/4" Heat Treated Steel Shank

\$74.50

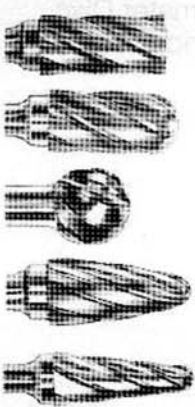









CODE	DIA	LENGTH	SHANK	SHAPE
SA-5	1/2	1"	6mm	CYLINDER
SC-3	3/8	3/4	6mm	CYLINDER RAD END
SDA-3	3/8	5/16	6mm	BALL SHAPE
SF-3	3/8	3/4	6mm	ROUND TREE SHAPE
SF-5	1/2	1"	6mm	ROUND TREE SHAPE
SL-3	3/8	1"1/16	6mm	14 DEGREE TAPER
SL-4	1/2	1"1/8	6mm	RADIUS END

# Tungsten Burrs

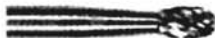
Burrs are priced each









## 40 Series : 1/8" Shaft - Requires Dremel 480 Collet

1/16th - 1/8th Diameter Head 1 1/2" overall length Double Cut 1/8th Shank Solid Tungsten Carbide

\$22.50	CODE	DIA	LENGTH	SHANK	SHAPE
	SB-43	1/8	9/16	1/8	CYLINDER
	SC-42	1/8	9/16	1/8	CYLINDER RAD END
	SD-42	1/8	1/8	1/8	BALL END
	SE-41	1/8	1/4	1/8	OVAL
	SF-42	1/8	1/2	1/8	ROUND TREE
	SG-44	1/8	1/2	1/8	POINTED TREE
	SM-41	1/8	1/2	1/8	12 DEGREE CONE
	SM-43	1/8	5/8	1/8	7 DEGREE CONE
	SN-42	1/8	3/16	1/8	INVERTED CONE

## 61 Series : 3/32" Shaft - Requires Dremel 481 Collet

3/32" Diameter Head 1 1/4" overall length Double Cut 3/32" Shank Solid Tungsten Carbide

\$22.50	CODE	DIA	LENGTH	SHANK	SHAPE
	SA-61A	3/32	3/8	3/32	CYLINDER
	SA-61	1/16	1/4	3/32	CYLINDER
	SD-61	3/32	3/32	3/32	BALL END
	SE-61	3/32	1/8	3/32	OVAL
	SG-61	3/32	1/4	3/32	POINTED TREE
	SF-61	3/32	1/4	3/32	ROUND TREE
	SC-61	3/32	3/8	3/32	CYLINDER RAD END
	SM-61	3/32	1/4	3/32	20 DEGREE CONE
	SN-61	3/32	1/8	3/32	INVERTED CONE